

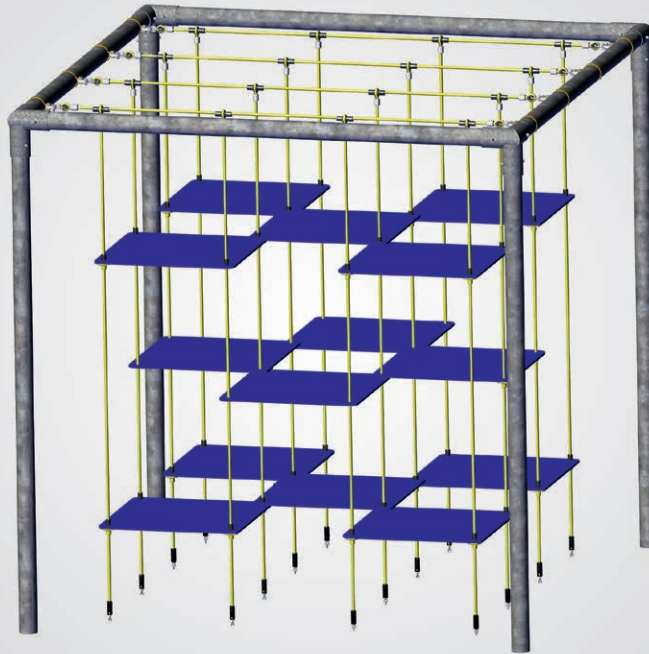









Le Cube

Réf. 4538-10



-  2,95 m
-  2,95 x 2,95 m
-  30,00 m²
-  5,71 x 5,71 m
-  1,90 m
-  5,30 m³
-  20
- 

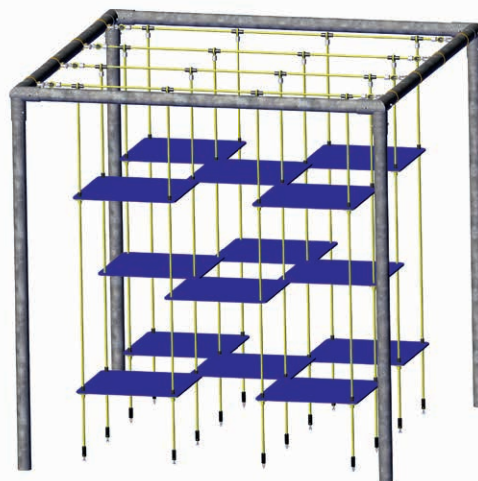
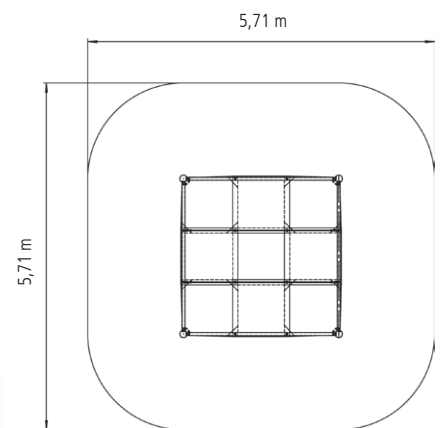

Q Membranes en caoutchouc disponibles en différents coloris.
Merci de nous contacter.