









# Le Pas de géant

Réf. 4530-60



-  2,45 m
-  Ø 2,30 m
-  50,00 m<sup>2</sup>
-  Ø 8,00 m
-  1,60 m
-  1,00 m<sup>3</sup>
-  8
- 

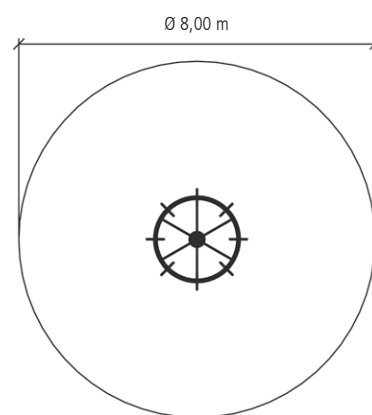

Composition :  
 1 mât en acier galvanisé à chaud (Ø 102 mm),  
 longueur 3,00 m  
 Étriers suspendus